

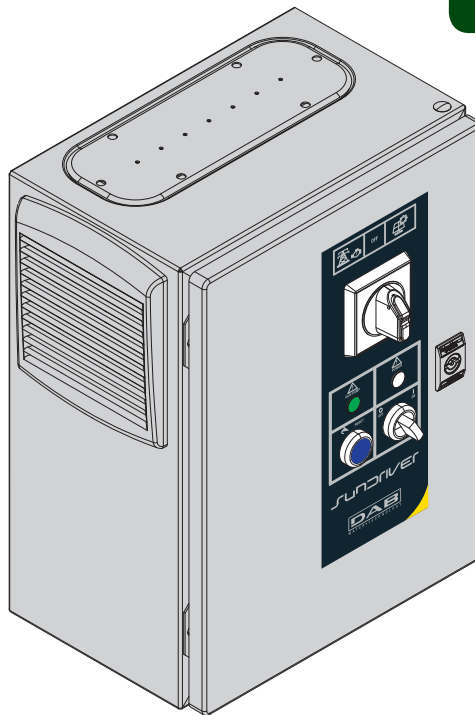





QUICK GUIDE

SUNDRIVER



0°C - 32°F Min
50°C - 122°F Max



TECHNICAL DATA



INSTALLATION



ELECTRICAL CONNECTIONS



TECHNICAL DATA	
Max Input VDC	420Volt
Max Input VAC	300Volt
Power	0.37-3kW 0.5-4 Hp
Max. environment temperature	50°C - 122°F
Grade of protection	IP54
Grade of protection USA	Nema rating 3S
230 Volt	
PUMP ON	290VDC/206 VAC
PUMP OFF	190VDC/135VAC
115 Volt	
PUMP ON	140VDC/100VAC
PUMP OFF	110VDC/80VAC

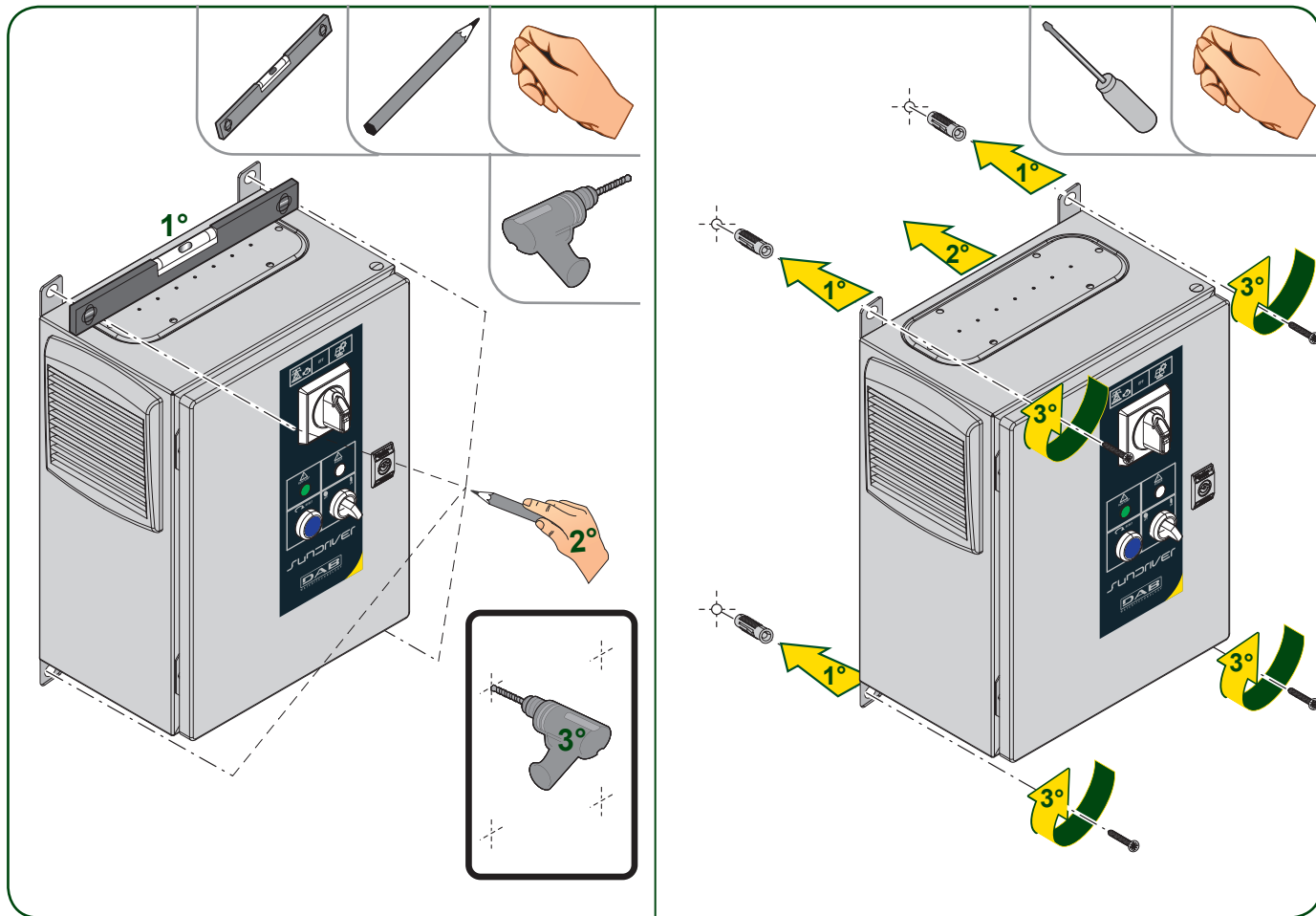

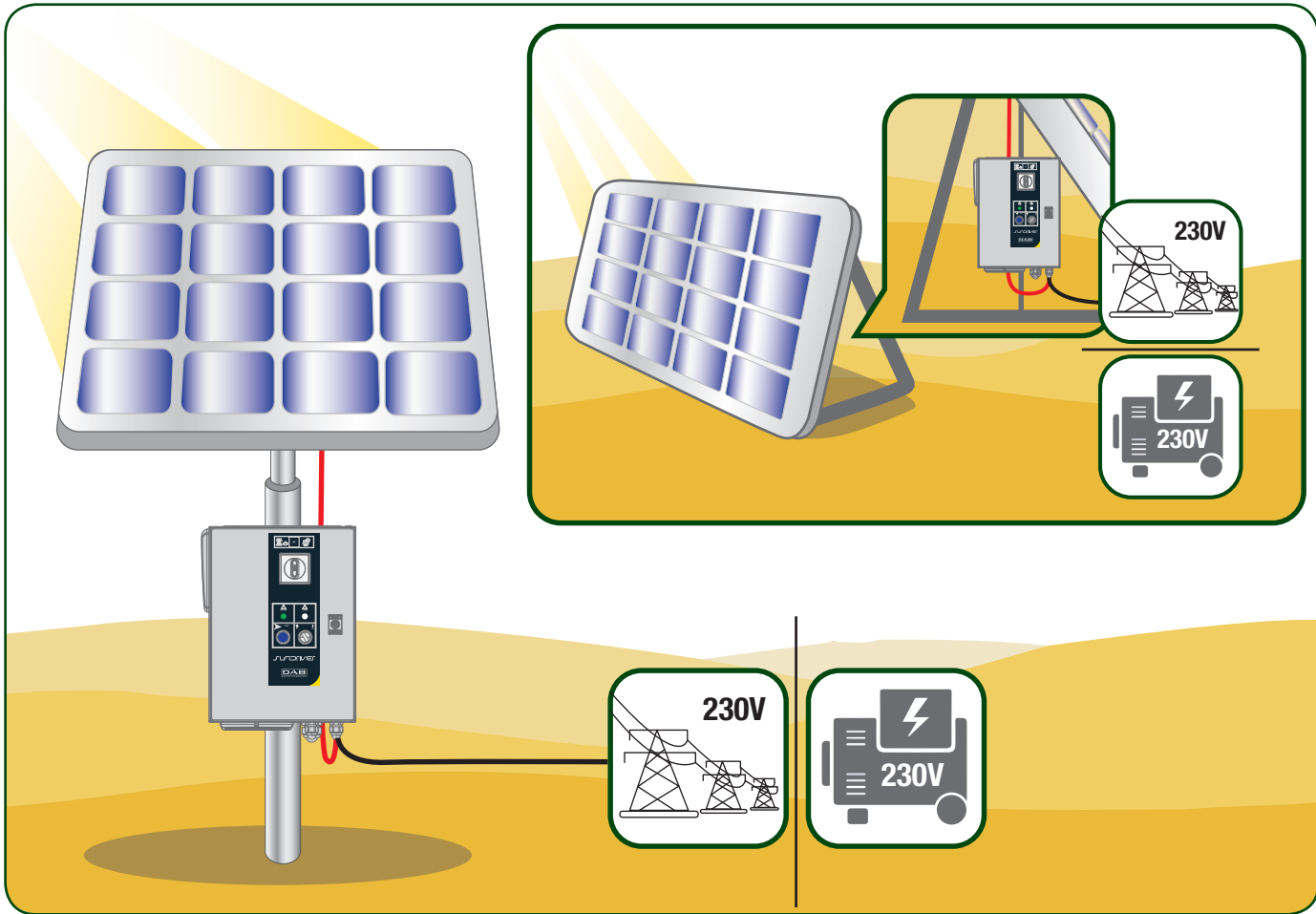

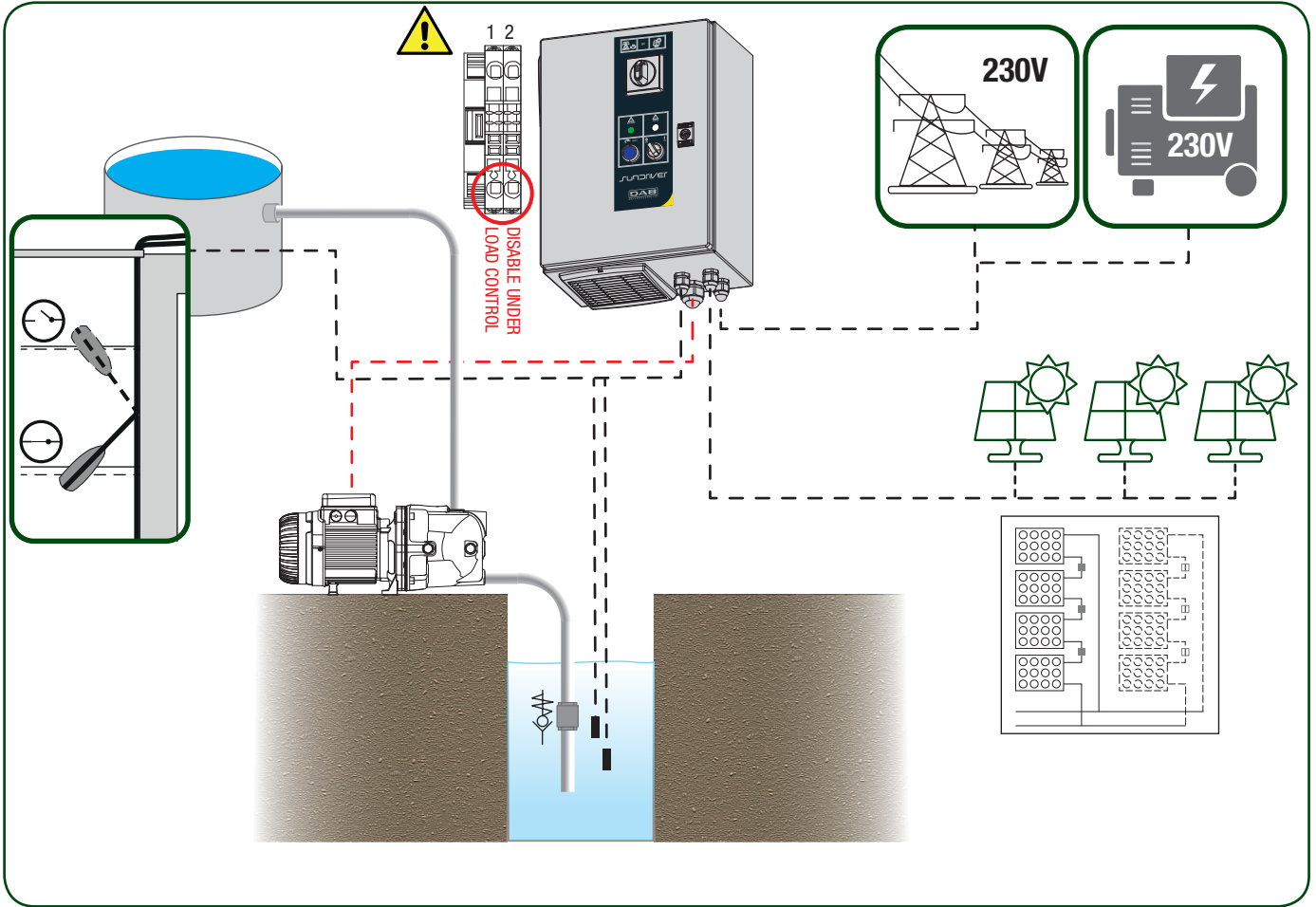

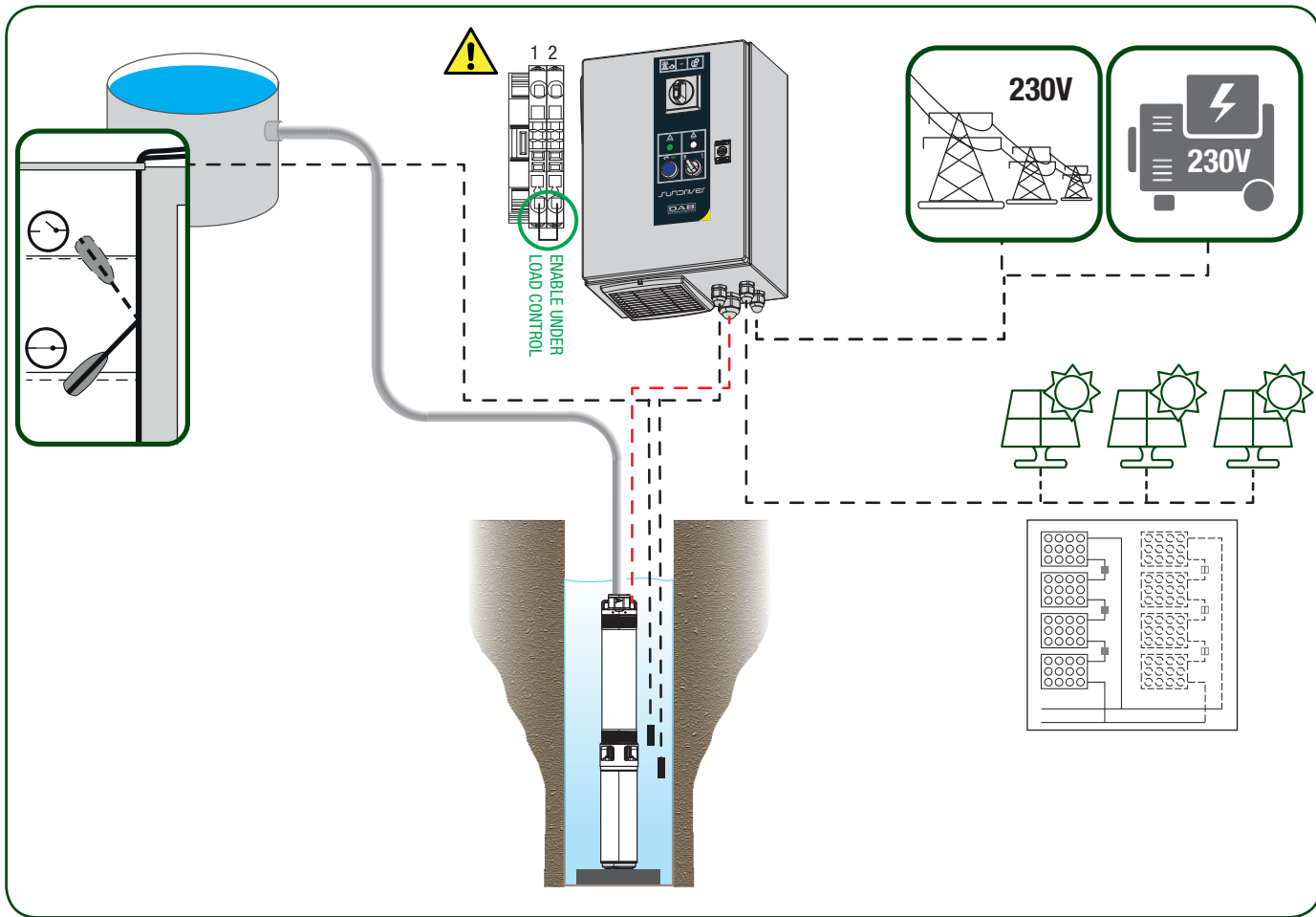

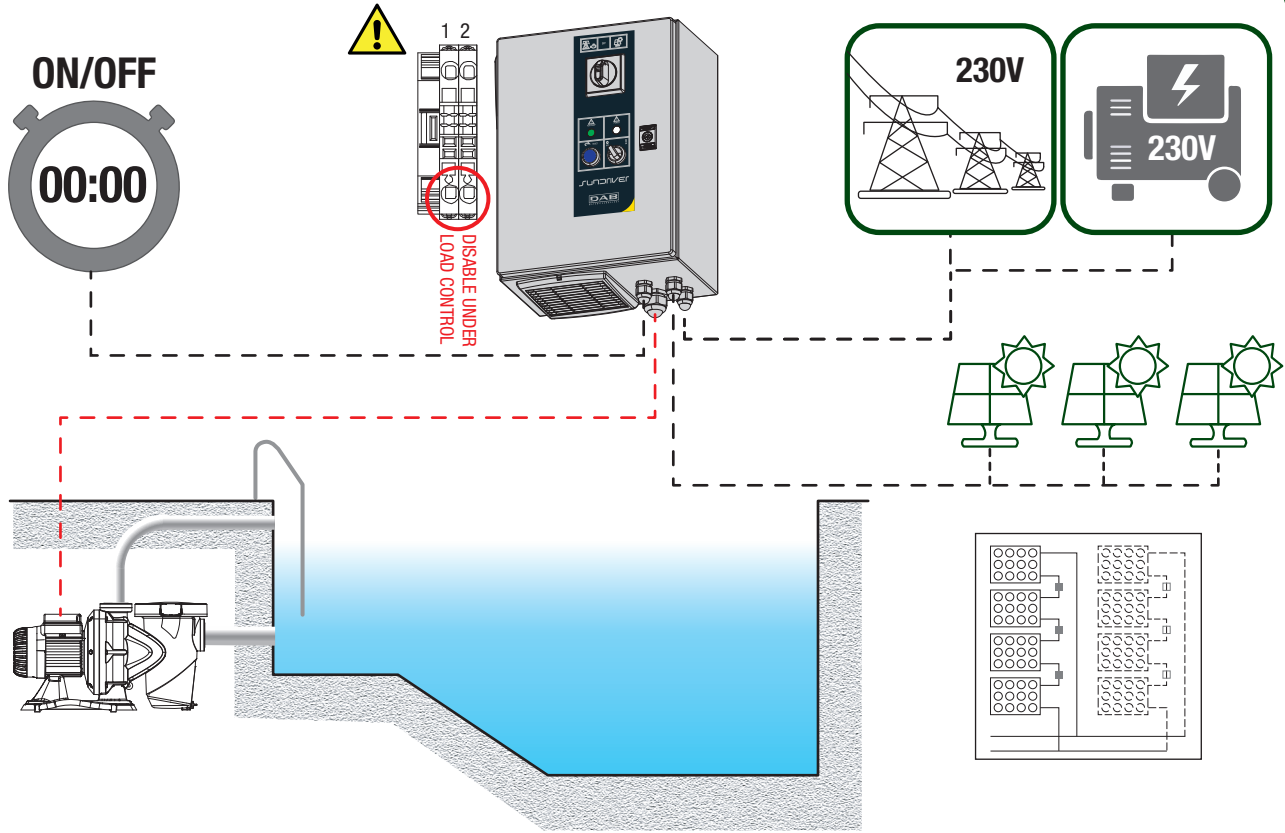

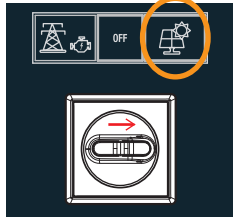
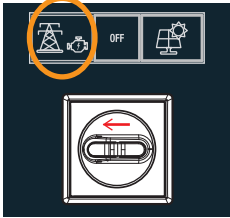
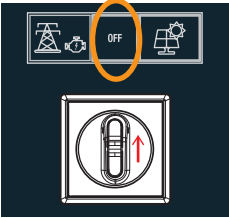

RUN PUMP

DEFAULT / RESET

- OVER CURRENT
- OVER VOLTAGE VDC
- OVER TEMPERATURE
- UNDER TORQUE

VENTILATION

OUTPUT MOTOR POWER

MAIN POWER SELECTOR

POWER

0-1 SELECTOR OFF/ON

INPUT DIGITAL SIGNAL

INPUT POWER

INPUT POWER

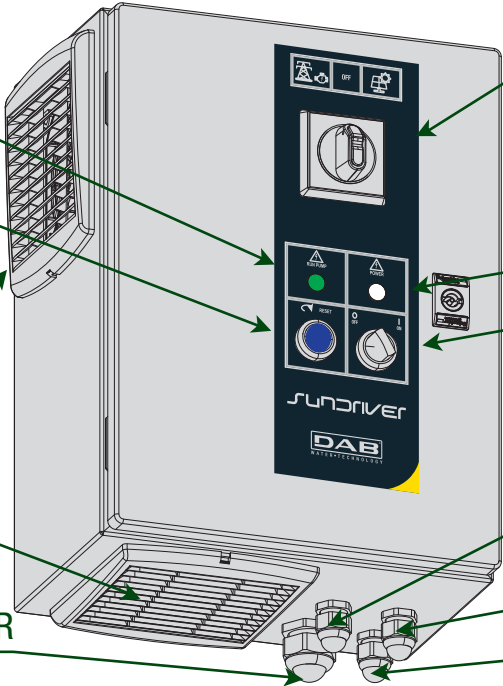

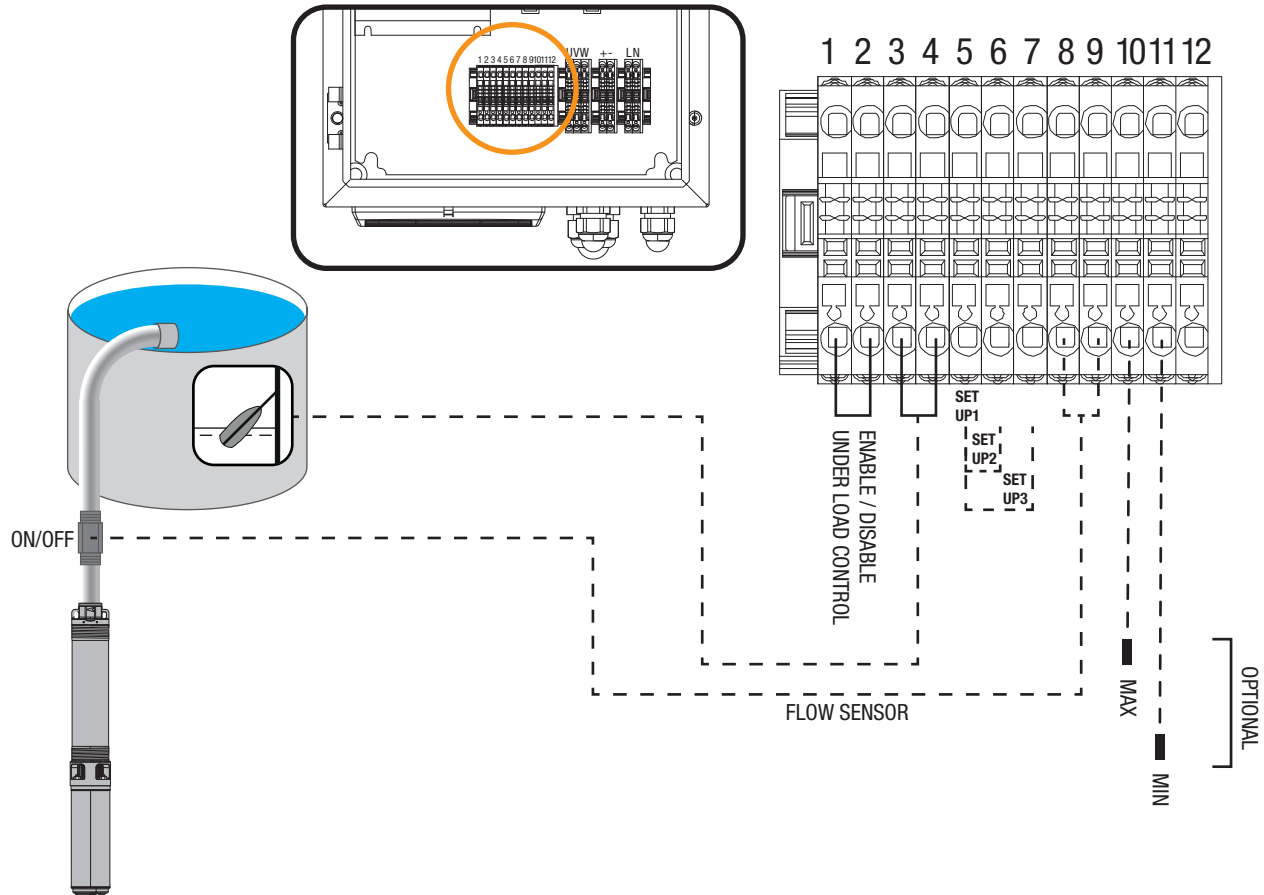



SUNDRIVER 1/50
SUNDRIVER 2/50
SUNDRIVER 3/50
SUNDRIVER 1/60
SUNDRIVER 2/60

U V W + - L N

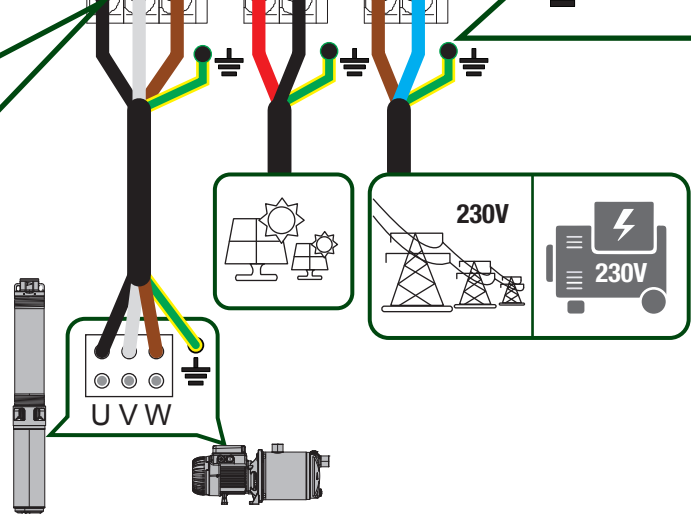
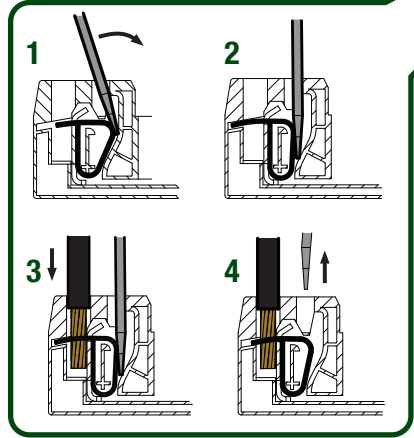
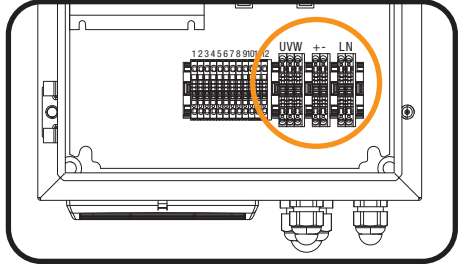
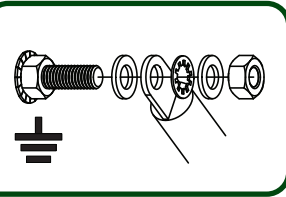
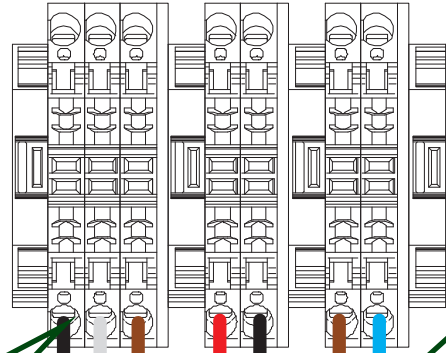

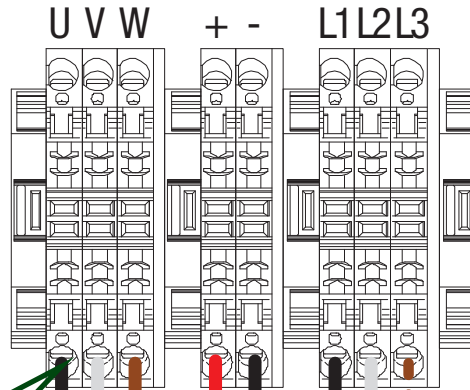
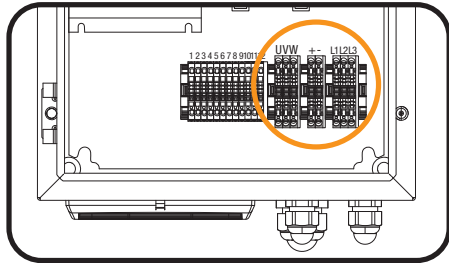

SUNDRIVER 4/50 (2.2kW)
SUNDRIVER 3/60

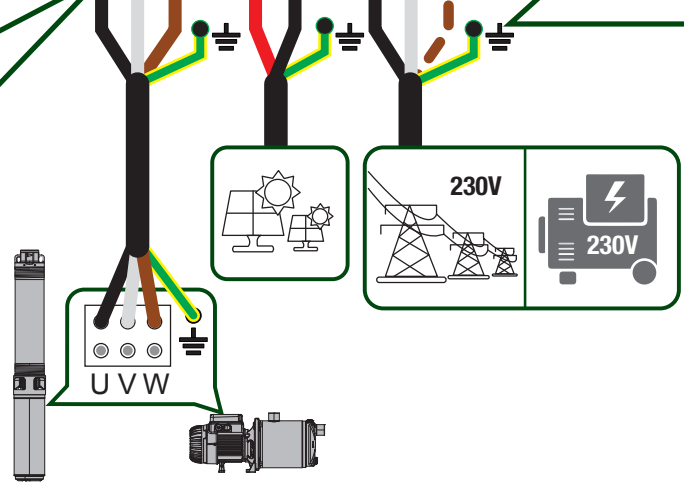
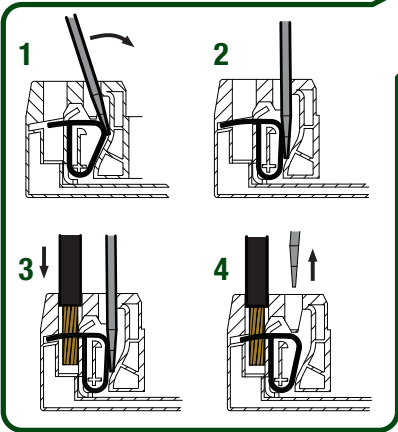
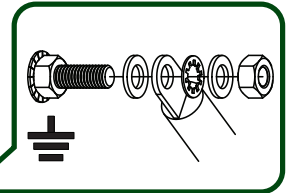

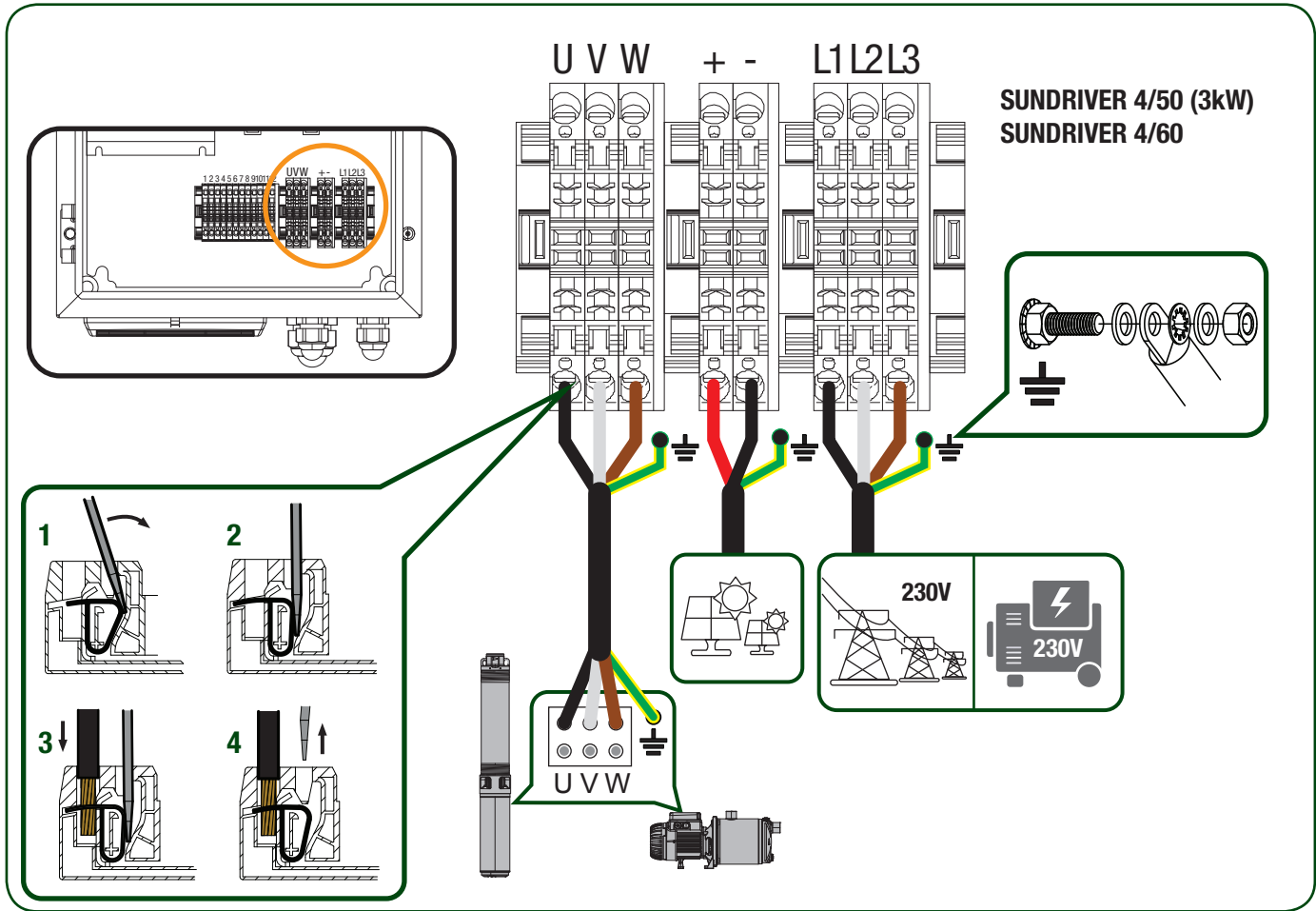



SETUP 1

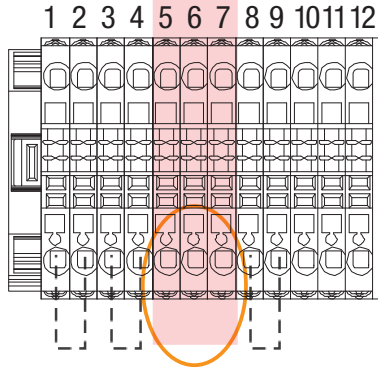

SETUP 2

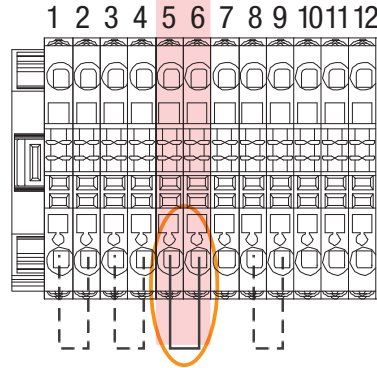

SETUP 3

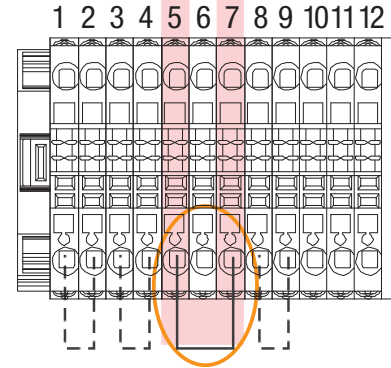

CODE	DESCRIPTION	GRID VOLTAGE	SETUP	POWER P2 [kW]	POWER Hp	RANGE Amp	PIN
PUMP SUPPLY 115Volt 50Hz							
60188600	SUNDRIVER 1/50	115V M/T	SETUP 1	0,37	0,5	4,7A (+0/-30%)	5 6 7
			SETUP 2	0,55	0,75	7,5A (+0/-30%)	5 6 7
			SETUP 3	0,75	1	9,1A (+0/-30%)	5 6 7
PUMP SUPPLY 230Volt 50Hz							
60188601	SUNDRIVER 2/50	230V M/T	SETUP 1	0,37	0,5	2,8A (+0/-30%)	5 6 7
			SETUP 2	0,55	0,75	3,8A (+0/-30%)	5 6 7
			SETUP 3	0,75	1	4,5A (+0/-30%)	5 6 7
60188602	SUNDRIVER 3/50	230V M/T	SETUP 1	1,1	1,5	6,2A (+0/-30%)	5 6 7
			SETUP 2	1,5	2	7,9A (+0/-30%)	5 6 7
60188603	SUNDRIVER 4/50	230V M/T - T/T	SETUP 1	2,2	3	10,4A (+0/-30%)	5 6 7
		230V T/T	SETUP 2	3	4	13,6A (+0/-30%)	5 6 7

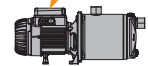



SETUP 1

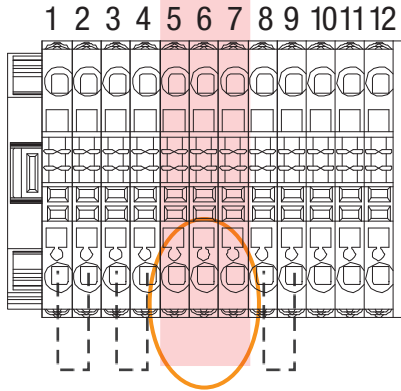

SETUP 2

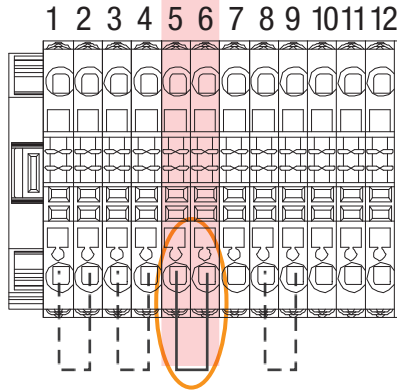

SETUP 3

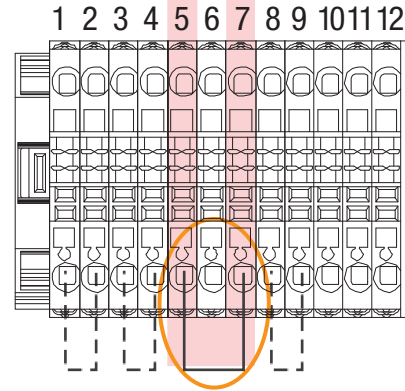

CODE	DESCRIPTION	GRID VOLTAGE	SETUP	POWER P2 [kW]	POWER P2 Hp	RANGE Amp	PIN
PUMP SUPPLY 115Volt 60Hz							
60188866	SUNDRIVER 1/60	115V M/T	SETUP 1	0,55	0,75	6,5A (+0/-30%)	5 6 7
			SETUP 2	0,9	1,2	9,5A (+0/-30%)	5 6 7
PUMP SUPPLY 230Volt 60Hz							
60188867	SUNDRIVER 2/60	230V M/T	SETUP 1	0,55	0,75	3,4A (+0/-30%)	5 6 7
			SETUP 2	0,9	1,2	5A (+0/-30%)	5 6 7
			SETUP 3	1,1	1,5	6,6A (+0/-30%)	5 6 7
60188868	SUNDRIVER 3/60	230V M/T - T/T	SETUP 1	1,5	2	7,6A (+0/-30%)	5 6 7
			SETUP 2	1,9	2,5	9A (+0/-30%)	5 6 7
			SETUP 3	2,2	3	9,5A (+0/-30%)	5 6 7
60188869	SUNDRIVER 4/60	230V T/T	SETUP 1	1,1	1,5 (115V)	12,5A (+0/-30%)	5 6 7
			SETUP 2	2,6	3,5	12,1A (+0/-30%)	5 6 7
			SETUP 3	3	4	12,5A (+0/-30%)	5 6 7

example: SETUP1

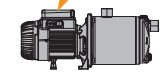



DAB PUMPS S.p.A.

Via M. Polo, 14 - 35035 Mestrino (PD) - Italy
Tel. +39 049 5125000 - Fax +39 049 5125950
www.dabpumps.com

07/18 cod.60188485